

7. november 2020

**6270955100**

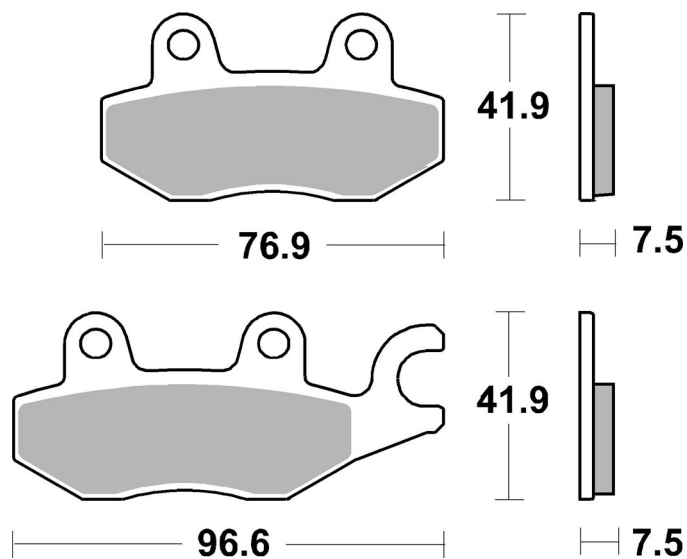

SBS ref. #	Available compounds
6270955100	RS • SRR



RECOMMENDED

