

7. november 2020

6370955100

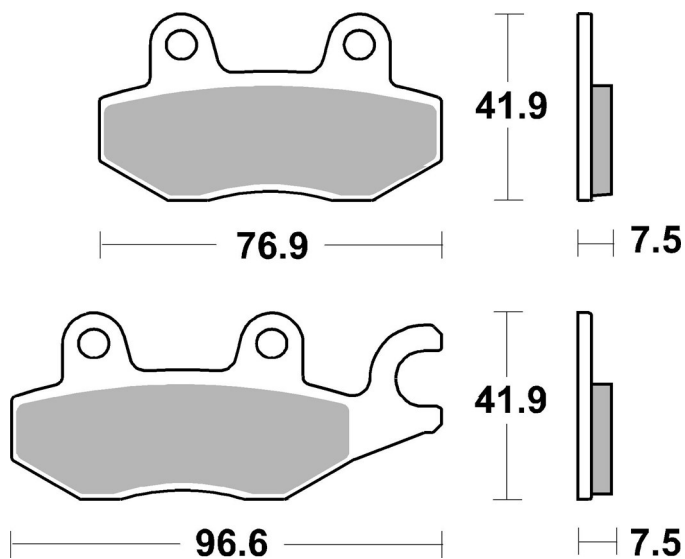

SBS ref. #	Available compounds
6370955100	DS-1 • TRR



RECOMMENDED

