

7. november 2020

6190931100

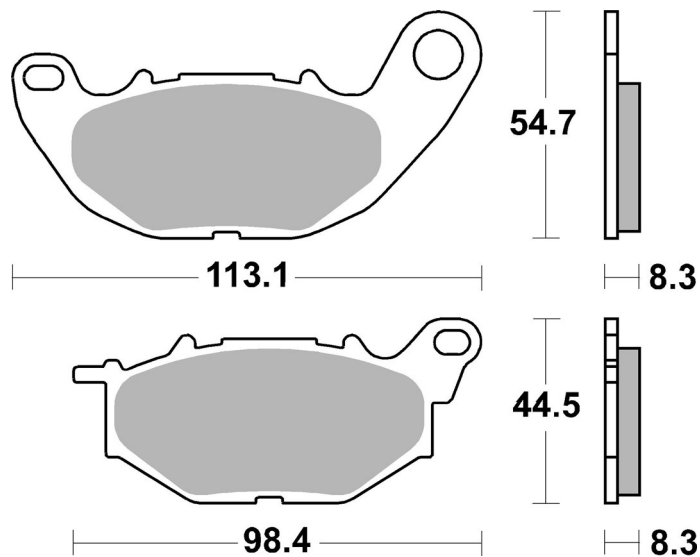

SBS ref. #	Available compounds
6190931100	HF • SC • ST



RECOMMENDED

