

7. november 2020

6490930100

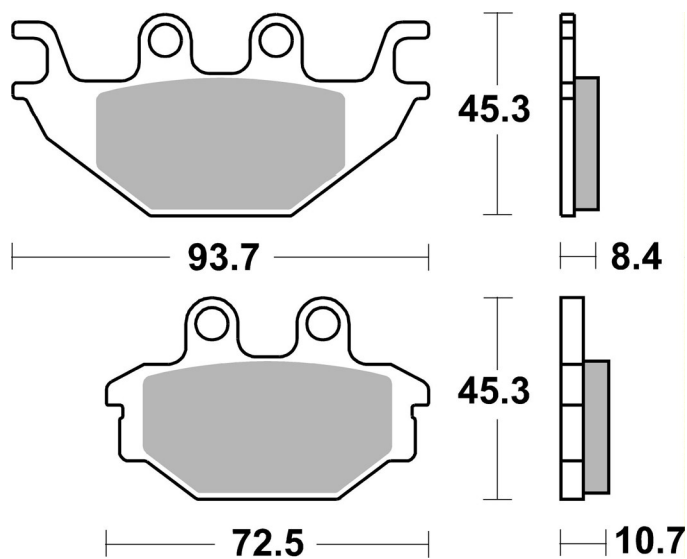

SBS ref. #	Available compounds
6490930100	H.HF • ST



RECOMMENDED

