

7. november 2020

6390869100

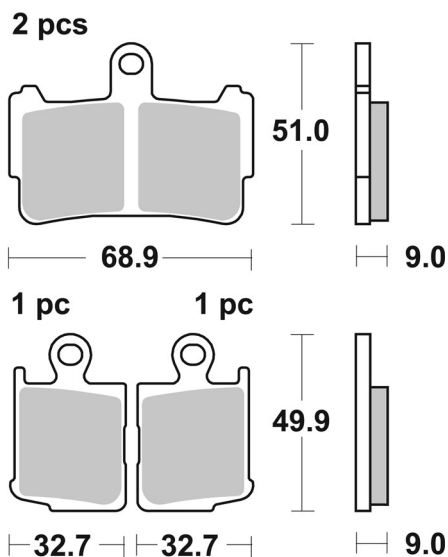

SBS ref. #	Available compounds
6390869100	SFP • SP



RECOMMENDED

