

7. november 2020

6280835100

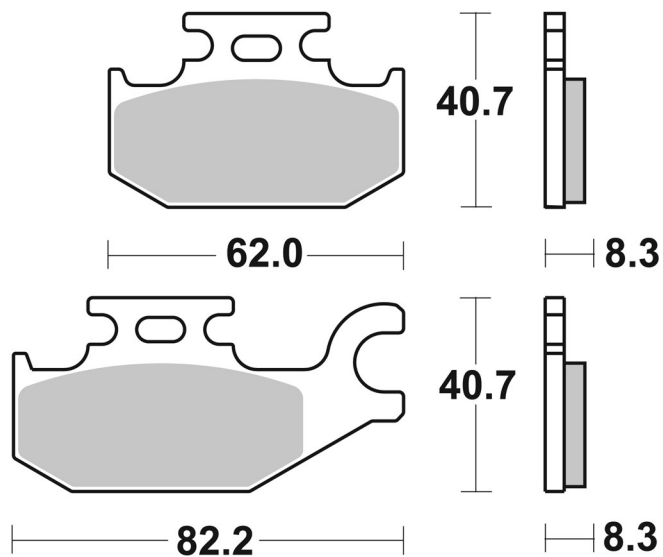

SBS ref. #	Available compounds
6280835100	MOR • ORR • RSI



RECOMMENDED

