

7. november 2020

6190754100

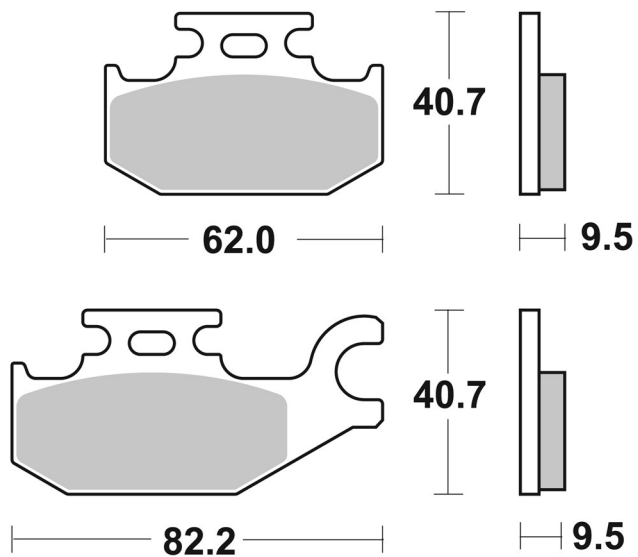

SBS ref. #	Available compounds
6190754100	HF • SC • ST



RECOMMENDED

