

7. november 2020

6390740100

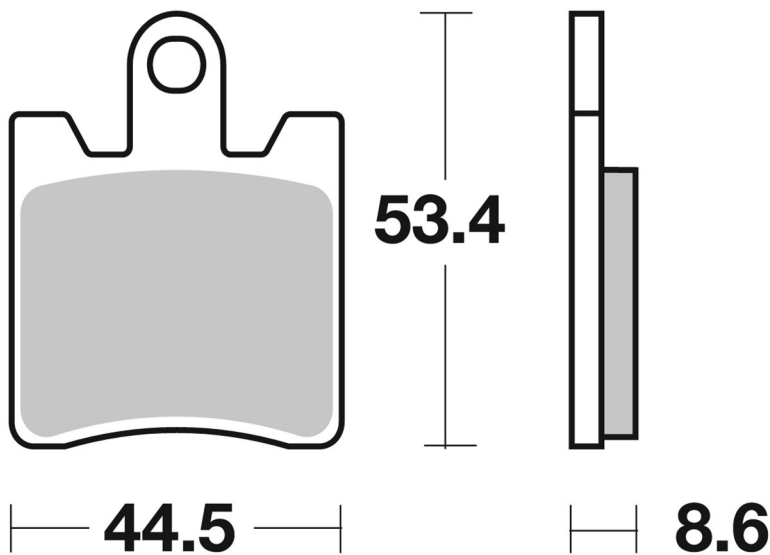

SBS ref. #	Available compounds
6390740100	SFP • SP



RECOMMENDED

