

7. november 2020

6390735100

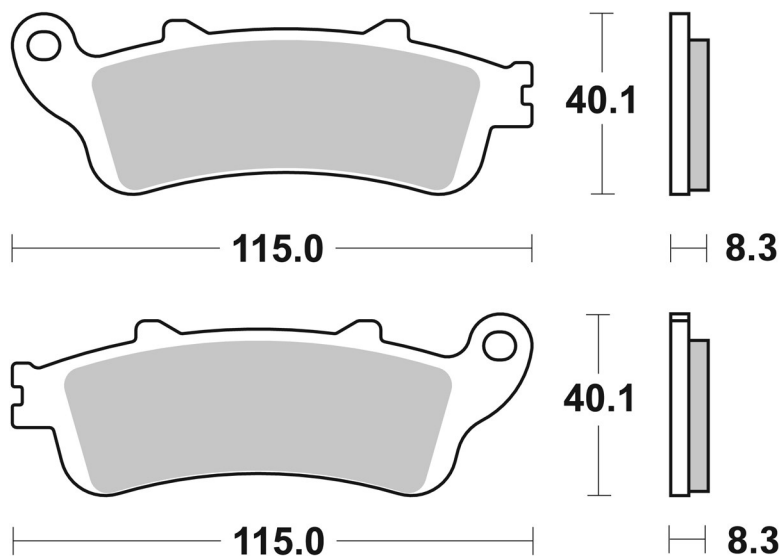

SBS ref. #	Available compounds
6390735100	SFP • SP



RECOMMENDED

