

7. november 2020

**6400627100**

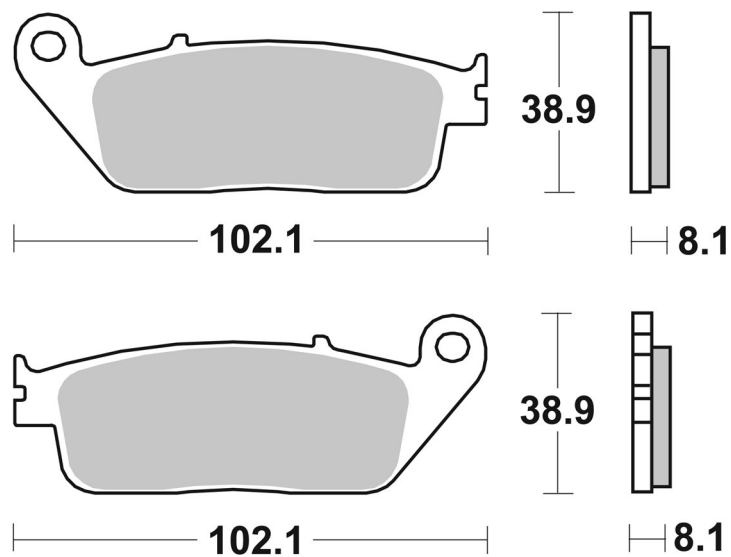

SBS ref. #	Available compounds
6400627100	DCC



**RECOMMENDED**

